

canfield connector
 8510 Foxwood Court
 Youngstown, Ohio 44514
 (330) 758-8299 Fax: (330) 758-8912
 www.canfieldconnector.com

SERIES 5FFAC

**FIELDBUS ADAPTER
 SOLENOID VALVE CONNECTORS**

General Description

The Canfield Series 5FFAC all-molded DIN solenoid valve connector/gasket/cord offer a completely molded plug and play design that interfaces female ISO (DIN 43650 Form "A"), MINI and 9.4mm (Industry Standard) and 8mm Sub-Micro (DIN 43650 "C") solenoid connections as shown on the following pages. Made from rugged yet flexible polyurethane, the connector housing boasts high durability factors and application versatility. The low profile "straight line" interface/cord configuration allows for installation in many limited space applications. The integrated gasket design boasts an IP67/NEMA 6 rating, is far better for environmental integrity than field wire versions and makes it impossible to lose the gasket! The 5FFAC and 5JFAC are the only molded valve connectors in the industry that feature bi-directional indicator lights and load suppression (not intended for UL 1449). UL and CSA versions are available as well. The Series 5FFAC is proudly **Made in the U.S.A.**

Dimensional Data

ALL DIMENSIONS ARE IN MILLIMETERS UNLESS OTHERWISE NOTED

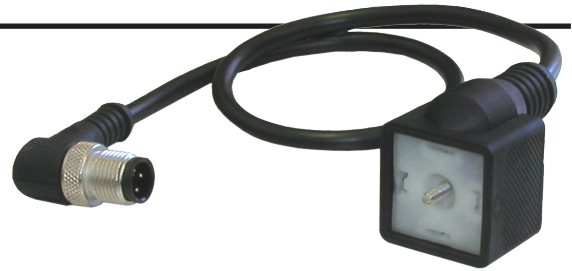
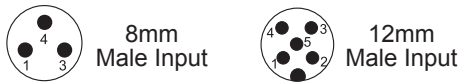

ISO shown above

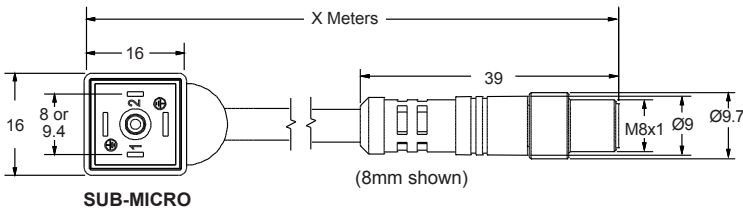

SUB-MICRO

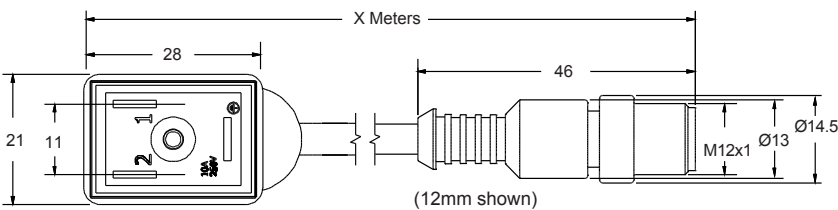

MINI

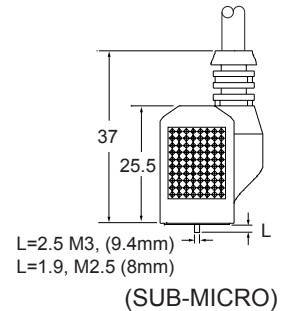

L=2.5 M3, (9.4mm)
 L=1.9, M2.5 (8mm)

(SUB-MICRO)

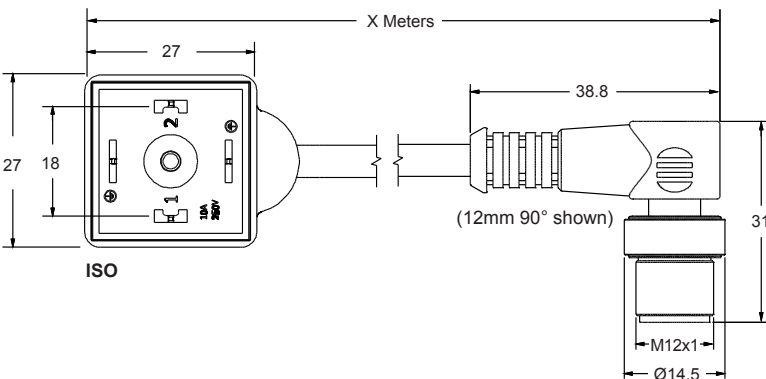

ISO

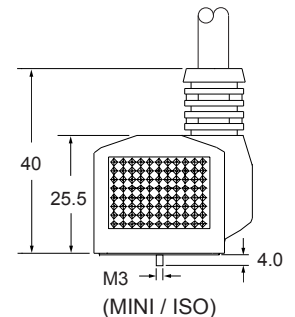

(MINI / ISO)

Technical Data

- Cable outlet: Molded construction with wire exiting out parallel to the face of the coil
- Color: Black (standard) or white translucent (for lighted versions)
- Cable types: Black PVC or PUR with & without shield
- Rated voltage max.: 120V AC/DC 50/60 Hz
- Voltage drop: 2.2 volt max.
- Current max: Continuous - 4 Amp
Inrush - 15 Amps for 15 ms

- Enclosure and molded in gasket materials: Polyurethane
- Ambient rated temperatures: -25° to 80°C
- Environment protection: IP 67 and NEMA 6
- Available in four sizes:
DIN 43650 Form "A" (ISO), EN175301-803:2000
DIN Form "C" (Sub-Micro 8mm), EN175301-803:2000
Industry standard (Sub-Micro 9.4mm pin spacing)
Industry standard (Mini 11mm pin spacing)
- Pin configurations:
For single solenoid valves, 2 connections plus ground,
Mini, ISO, Sub-Micro 8mm and Sub-Micro 9.4mm

Ordering Guide

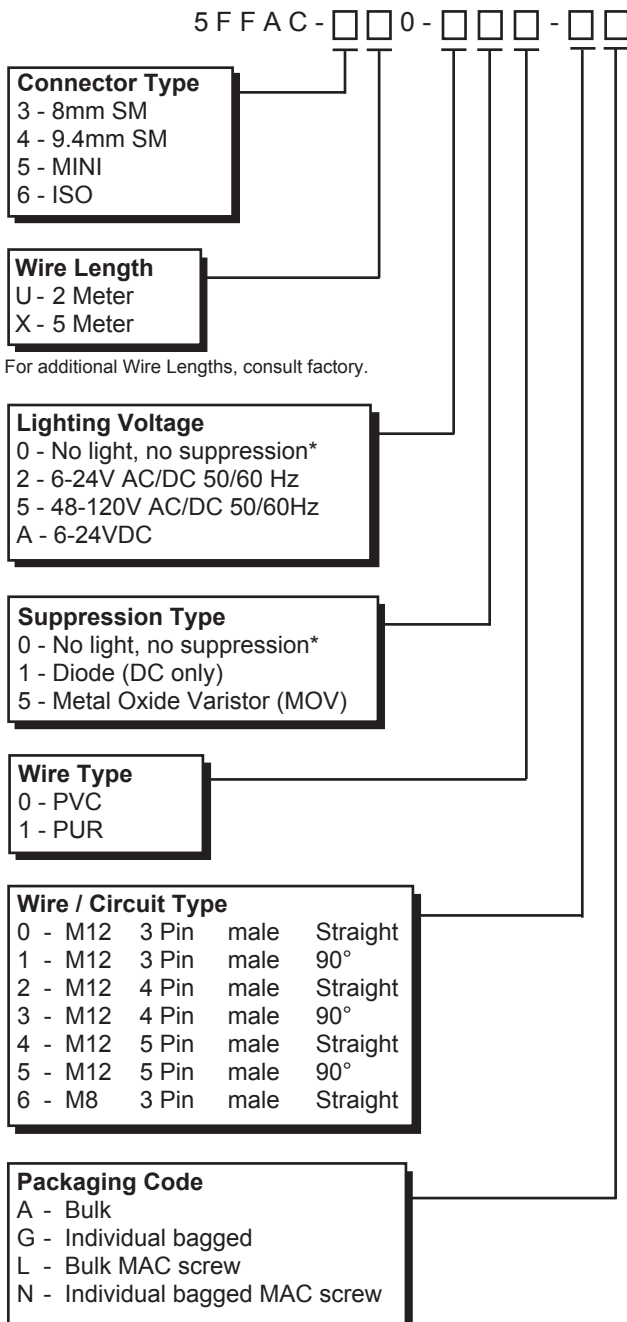

Circuit Types

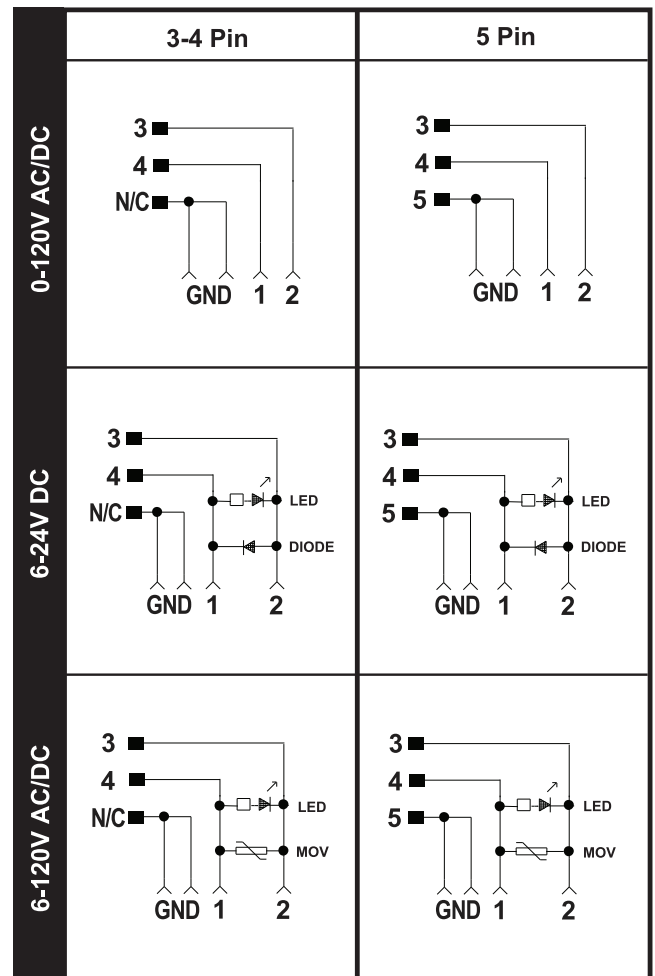

Ordering Example:

5FFAC-3U0-250-2A

8mm SM, 2 meter wire length, 6-24V AC/DC 50/60 Hz, lighted, MOV, PVC wire type, M12, 4 pin, male, straight, bulk

* Rated 120V AC/DC 50/60Hz

MAC is the registered trademark of MAC Valves, Inc.

All connectors come standard with integrated gasket.

Note: Slight discoloration may occur to translucent material after prolonged exposure to UV rays.